



CONTRACTOR	
PROJECT	DATE
PREPARED BY	MODEL :

SERIES SPECIFICATIONS **WP21MG**

2G, 1" DEPTH, FLAT COVER, METALLIC, GRAY



LINE DRAWING

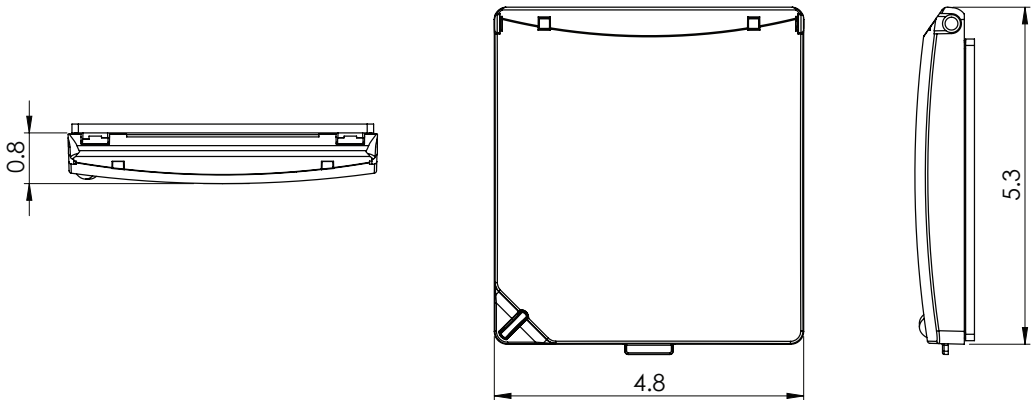

CONSTRUCTION

of Gangs
2

of Inserts
6

of Combinations
73

Base Material
die cast

Cover Material
die cast

Gasket Material
Polyethylene Foam

Min. Temperature
-60°F (-51°C)

Max. Temperature
120°F (49°C)

Base Color
Gray

Cover Color
Gray

Insert Material
Gray

Gasket Thickness
3mm

Depth
1.5"

Hinge Location
Horiz & Vert

Lock Type
Padlock (not included)

APPLICATION AND PERFORMANCE SPECIFICATION INFORMATION IS SUBJECT TO CHANGE WITHOUT NOTIFICATION





CONTRACTOR	
PROJECT	DATE
PREPARED BY	MODEL :

CONSTRUCTION

Mounting Hardware
2 QTY 6-32 Screws

Cord Diameter
N/A

CERTIFICATIONS/WARRANTY

Listing
c-UL-us Listed

NEMA Rating
3R

Warranty
Guaranteed for one year from the purchase date of the product, against mechanical defects in manufacturing.

ORDERING INFORMATION

Part Number: WP21MG

Weight : 0.50 lbs

APPLICATION AND PERFORMANCE SPECIFICATION INFORMATION IS SUBJECT TO CHANGE WITHOUT NOTIFICATION



404 NW ENTERPRISE DR. PORT ST. LUCIE, FL 34986 | 772.408.5213 | WWW.RPP-USA.COM